

Vi030-6B / Vi035-6B

[Gross] 20.4kW | [Gross] 20.4kW



Lifting capacity

Excavator equipped with ROPS/FOPS and rubber tracks (without quick coupler and without bucket)

- r** : Reach from swing center line : mm (in)
- h** : Lift point height : mm (in)
- w** : Lifting capacity : kg (lbs)
- P** : Lift point

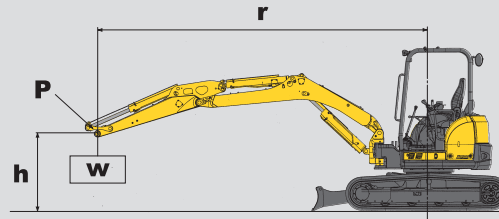
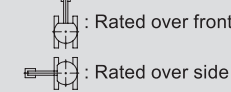

- The rated lifting capacities that are indicated below are based on ISO 10567 and do not exceed 87% of the excavator's hydraulic lifting capacity or 75% of its static tilt load (tipping load) capacity.
- The following operating criteria are also applicable to the calculation of these maximum loads;
 - The "Lift point" is the location of the front point on the arm
 - The three indicated machine position are :
 - arm over the front end (blade down),
 - arm over the front end (blade up), and
 - arm over the side (blade up).
- The weight of the excavator's bucket, hook, sling and other lifting accessories have been taken into consideration when calculating these maximum loads.

Vi030-6B

LIFT POINT HEIGHT	r : REACH mm(in)												
	RATED LIFT CAPACITY OVER END BLADE DOWN kg (lbs)				RATED LIFT CAPACITY OVER END BLADE UP kg (lbs)				RATED LIFT CAPACITY OVER SIDE BLADE UP kg (lbs)				
h : mm(in)	MAX	3000 (118.1)	2500 (98.5)	2000 (78.7)	MAX	3000 (118.1)	2500 (98.5)	2000 (78.7)	MAX	3000 (118.1)	2500 (98.5)	2000 (78.7)	
3000 (118.1)	* 760 (1675)	* 600 (1322)			510 (1124)	* 600 (1322)			390 (859)	* 600 (1322)			
2500 (98.5)	* 760 (1675)	* 710 (1565)			430 (947)	* 710 (1565)			330 (727)	540 (1190)			
2000 (78.7)	* 780 (1719)	* 850 (1873)	* 900 (1984)		390 (859)	660 (1455)	* 900 (1984)		280 (617)	490 (1080)	700 (1543)		
1000 (39.4)	* 830 (1829)	* 1180 (2601)	* 1530 (3373)		360 (793)	610 (1344)	820 (1807)		250 (551)	430 (947)	580 (1278)		
0 (Ground)	* 870 (1918)	* 1300 (2866)	* 1680 (3703)	* 2170 (4784)	360 (793)	570 (1256)	750 (1653)	1120 (2469)	270 (595)	400 (881)	520 (1146)	760 (1675)	
-1000 (-39.4)	* 950 (2094)	* 1180 (2601)	* 1560 (3439)	* 1870 (4122)	460 (1014)	550 (1212)	750 (1653)	1060 (2336)	330 (727)	400 (881)	540 (1190)	730 (1609)	
-1500 (-59.1)	* 930 (2050)		* 1250 (2755)	* 1690 (3725)	610 (1344)			780 (1719)	1080 (2380)	450 (992)		570 (1256)	780 (1719)

Vi035-6B

LIFT POINT HEIGHT	r : REACH mm(in)											
	RATED LIFT CAPACITY OVER END BLADE DOWN kg (lbs)				RATED LIFT CAPACITY OVER END BLADE UP kg (lbs)				RATED LIFT CAPACITY OVER SIDE BLADE UP kg (lbs)			
h : mm(in)	MAX	3500 (137.8)	3000 (118.1)	2500 (98.5)	MAX	3500 (137.8)	3000 (118.1)	2500 (98.5)	MAX	3500 (137.8)	3000 (118.1)	2500 (98.5)
3000 (118.1)	* 780 (1719)	* 740 (1631)	* 730 (1609)		480 (1058)	600 (1322)	* 710 (1565)		450 (992)	580 (1278)	* 710 (1565)	
2000 (78.7)	* 800 (1763)	* 870 (1918)	* 970 (2138)	* 1130 (2491)	410 (903)	580 (1278)	750 (1653)	* 1110 (2447)	370 (815)	570 (1256)	700 (1543)	* 1110 (2447)
1000 (39.4)	* 820 (1807)	* 1060 (2336)	* 1310 (2888)	* 1730 (3813)	360 (793)	540 (1190)	690 (1521)	900 (1984)	340 (340)	510 (1124)	640 (1410)	820 (1807)
0 (Ground)	* 850 (1873)	* 1180 (2601)	* 1460 (3218)	* 1820 (4012)	370 (815)	510 (1124)	640 (1410)	850 (1873)	360 (793)	480 (1058)	600 (1322)	780 (1719)
-1000 (-39.4)	* 880 (1940)	* 1090 (2403)	* 1340 (2954)	* 1680 (3703)	420 (925)	490 (1080)	630 (1388)	840 (1851)	400 (881)	460 (1014)	600 (1322)	760 (1675)
-1500 (-59.1)	* 870 (1918)	* 930 (2050)	* 1170 (2579)	* 1420 (3130)	510 (1124)	490 (1080)	640 (1410)	840 (1851)	480 (1058)	480 (1058)	610 (1344)	760 (1675)
-2000 (-78.7)	* 840 (1851)				670 (1477)				640 (1410)			

Note : The maximum loads marked with an asterisk (*) were limited by the Excavator's hydraulic lifting capacity rather than by its static tilt load (tipping load) capacity.

Standard Equipment

- Blade
- Boom swing function
- Cylinder cover (boom, arm, bucket, blade)
- Rubber or Steel tracks
- Back mirror
- ROPS / FOPS Canopy, Cabin
- Work light on canopy
- Windshield washer (cabin)
- LCD monitor
- Joystick pilot controls
- Arm rests
- Suspension and reclining seat
- Seat belt
- P.T.O switch
- Travel dual speed switch
- Auto deceleration
- Eco mode
- Engine stop switch
- Air conditioner
- External power socket (12V)
- Cup holder
- Floor mats
- Evacuation hammer (cabin)

Please note that the standard equipment may vary from this list. Consult your Yanmar dealer for confirmation

YANMAR CONSTRUCTION EQUIPMENT CO.,LTD.

OVERSEAS SALES DEPT.
 MARKETING & SALES DEPT.
 1717-1 Kumano, Chikugo, Fukuoka 833-0055, JAPAN
 TEL +81-942-53-5465 FAX +81-942-53-5132
 yanmar.com

All data subject to change without notice.

Dimensions Unit : mm (ft-in)

	Vi030-6B		Vi035-6B	
	Canopy spec / Cabin spec			
	Quick Coupler	without Quick Coupler	Quick Coupler	without Quick Coupler
A	2200 (7'3") 1980 (6'6")	2050 (6'9") 1840 (6'0")	2170 (7'1") 1950 (6'5")	2020 (6'8") 1810 (5'11")
B	4520 (14'10")	4470 (14'8")	4770 (15'8")	4730 (15'6")
C	4890 (16'1")	4730 (15'6")	5270 (17'3")	5110 (16'9")
D	5020 (16'6")	4870 (16'0")	5390 (17'8")	5230 (17'2")
E	2160 (7'1")			
F	1480 (4'10")	1630 (5'4")		
G	325 (1'1")	370 (1'3")		
H	375 (1'3")	425 (1'5")		
I	3110 (10'2")	2950 (9'8")	3440 (11'3")	3290 (10'10")
J	2160 (7'1")	2290 (7'6")	2410 (7'11")	2560 (8'5")
K	2970 (9'9")	2820 (9'3")	3250 (10'8")	3100 (10'2")
L	4710 (15'5")	4550 (14'11")	5110 (16'9")	4960 (16'3")
M	3010 (9'11")	3160 (10'4")	3410 (11'2")	3560 (11'8")
N	1110 (3'8")	1230 (4'0")	1240 (4'1")	1360 (4'6")
O	300 (1'0")			
P	540 (1'9")	590 (1'11")		
Q	85 (0'3")	15 (0'1")		
R	135 (0'5")	65 (0'3")		
S	2460 (8'1")	2470 (8'1")		
T	1250 (4'1")	1440 (4'9")		
U	1550 (5'1")	1740 (5'9")		
V	1550 (5'1")	1740 (5'9")		
W	775 (2'7")			

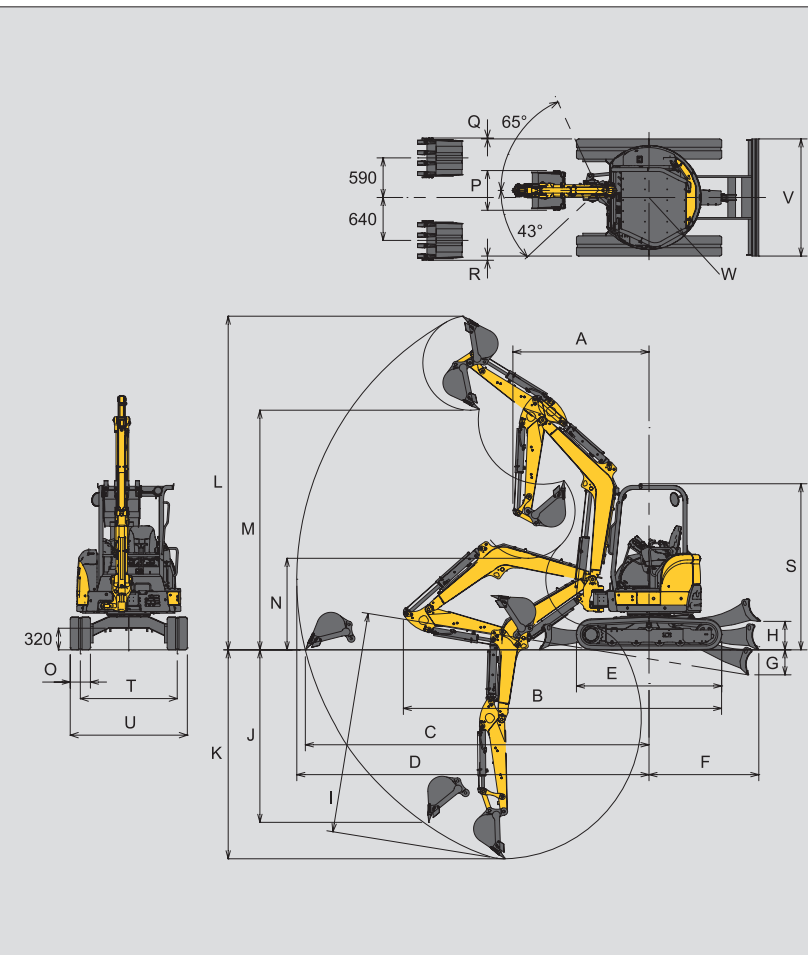

Specifications

Model	Vi030-6B				Vi035-6B						
	Canopy		Cabin		Canopy		Cabin				
Spec											
Type	Quick Coupler	without Quick Coupler	Quick Coupler	without Quick Coupler	Quick Coupler	without Quick Coupler	Quick Coupler	without Quick Coupler			
Operating Weight	Rubber track	kg (lbs)	3175 (7000)	3125 (6890)	3315 (7308)	3265 (7198)	3585 (7905)	3535 (7795)	3725 (8214)	3675 (8103)	
	Steel track	kg (lbs)	3275 (7220)	3225 (7110)	3415 (7529)	3365 (7419)	3685 (8125)	3635 (8015)	3825 (8434)	3775 (8324)	
Engine	Type	Water-cooled 4-cycle diesel									
	Model	YANMAR 3TNV88-ZSBV									
	Rated Output	kW (hp) / rpm		20.4 (27.3) / 2200 [Gross]							
Performance	Bucket capacity, standard (ISO heaped)	cu.m (cu.ft)				0.10 (3.53)					
	Max Digging Force	Bucket	kN (lbf)	23.5 (5283)	29.9 (6722)	23.5 (5283)	29.9 (6722)	25.1 (5643)	32.1 (7216)	25.1 (5643)	32.1 (7216)
		Arm	kN (lbf)	16.7 (3754)	18.1 (4069)	16.7 (3754)	18.1 (4069)	18.8 (4226)	20.4 (4586)	18.8 (4226)	20.4 (4586)
	Traveling Speed, High/Low	km / h (MPH)		4.5 (2.7) / 2.7 (1.6)							
	Swing Speed	rpm		10.5							
	Boom Swing Angle, (L / R)	degrees		43 / 65							
Ground Contact Pressure	Rubber track	kPa (PSI)	29.3 (4.25)	28.9 (4.19)	30.6 (4.44)	30.1 (4.37)	33.1 (4.80)	32.7 (4.74)	34.3 (4.97)	33.9 (4.92)	
	Steel track	kPa (PSI)	30.2 (4.38)	29.8 (4.32)	31.4 (4.55)	31.0 (4.50)	34.0 (4.93)	33.6 (4.87)	35.2 (5.10)	34.8 (5.05)	
Hydraulic System	Pump Capacity	L / min (GPM)	37.4 (9.9) x 2 [Variable displacement pump]				37.0 (9.8) x 2 [Variable displacement pump]				
			20.9 (5.5) x 1, 9.9 (2.6) x 1 [Gear pump]				26.2 (6.9) x 1, 10.8 (2.9) x 1 [Gear pump]				
	Main Relief Set Pressure	MPa (PSI)	20.6 (2988) x 2		19.6 (2843) x 1		22.1 (3205) x 2		21.1 (3059) x 1		
Blade	Width	mm (ft-in)	1550 (5'1")				1740 (5'8")				
Dimensions	Stroke, Raise / Lower from G.L.	mm (ft-in)	375 (1'3") / 325 (1'1")				425 (1'5") / 370 (1'3")				
Fuel tank capacity	L (Gals)	41 (10.8)									

Hydraulic PTO

Model	Vi030-6B			Vi035-6B		
	Output	L / min (GPM)		MPa (PSI)	L / min (GPM)	
2200RPM		1100RPM	2200RPM		1100RPM	
Combined Flow, Double Actions	19.6 (2842)	58.3 (15.4)	29.15 (7.7)	22.1 (3204)	63.2 (16.7)	31.6 (8.35)

Designed for Operators and the Environment



CLEAN DIESEL ENGINE

Allowing reduced emissions and stubborn strength

[Features our next-generation electronically controlled engine]

With plenty of power on tap, Yanmar's TNV direct injection diesel engines are the result of our single-minded pursuit of advanced technologies, such as our improved fuel injection system, that allow even cleaner emissions and reduced noise. This lets us contribute to a work environment that is kind to both people and the globe.



[3TNV88]
20.4kW
/ 2200rpm

Improved fuel combustion efficiency
You will see 20% fuel savings against previous models, thanks to our new hydraulic system that increases hydraulic circuit efficiency and the energy savings from our electronically controlled engines.

Electronically controlled engine	+	More efficient hydraulics
20% better fuel economy over previous models		
Previous Model		20% down
New Model		
Eco Mode		15% down

[Eco Mode]
Switching to this controls the engine speed for efficiency and greatly reduces fuel consumption.

[Auto Deceleration]
Switching the operating levers to neutral automatically drops the engine rpm and reduces on both fuel consumption and noise.

Achieving even greater fuel savings

TRUE ZERO SWING TAIL

Swivel without worrying about what's behind you

The rear remains within the vehicle width, operating near walls is easy, pleasant, and goes smoothly.

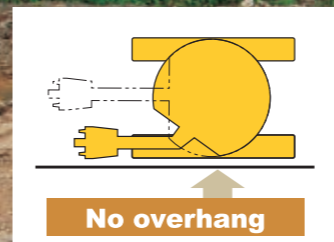

UNIVERSAL DESIGN

A wider range of people can operate the machinery easily and enjoyably

Easily check all sorts of important information even at night

[Back light large-screen LCD monitor]

Important information such as operating status and problems are shown using lights and buzzers on and an easy-to-read monitor.

LCD monitor display examples

2012/03
Mon Tue Wed Thu Fri Sat Sun
1 2 3 4
5 6 7 8 9 10 11
12 13 14 15 16 17 18
19 20 21 22 23 24 25
26 27 28 29 30 31

Hours of operation over a month

2012/03/21
AM 2.6 h
PM 0.0 h
2.6 h
Hours of operation in a day

Easy to grasp and open with either hand

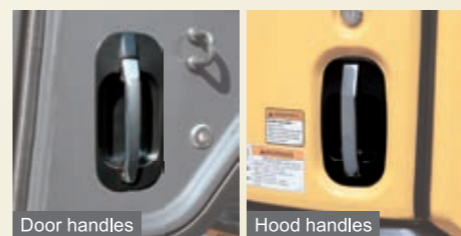

Easy to grip making it easy to climb up or down



The seat adjusts to suit operator size and position



Opening the cab turns the interior light on for a few seconds, improving safety



Easy and simple to operate



Safe, Simple, Stable Operability



Compliant with ROPS / FOPS standards
[Cabin, canopy]



Durable
[Steel plate hood]



1740mm (Vi035-6B)
(5'9")

Than previous models **12% increase**

Allows for increased lifting capacity and stable, efficient operation.

[Optimum machine balance through a wider track]

Attaching the optional counterweights lets you increase the lifting capacity even further.

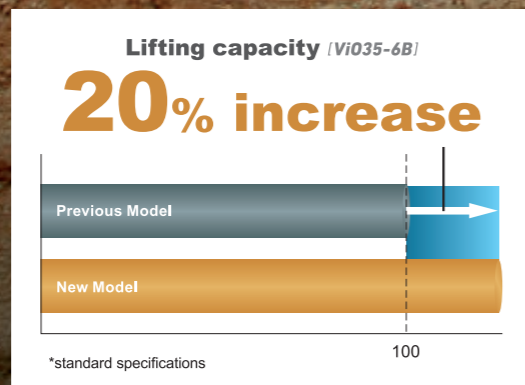

We also supply tough steel tracks. (Steel track specifications)



[Spring steel cylinder guards protect the cylinder rods]



Guarded from damage
[Boom-mounted light]

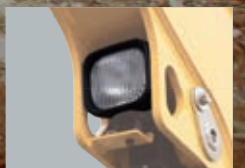

[Engine stop switch]



A Pleasant Operating Environment

Remain alert and relaxed even after hours of work
[Generous operating space]

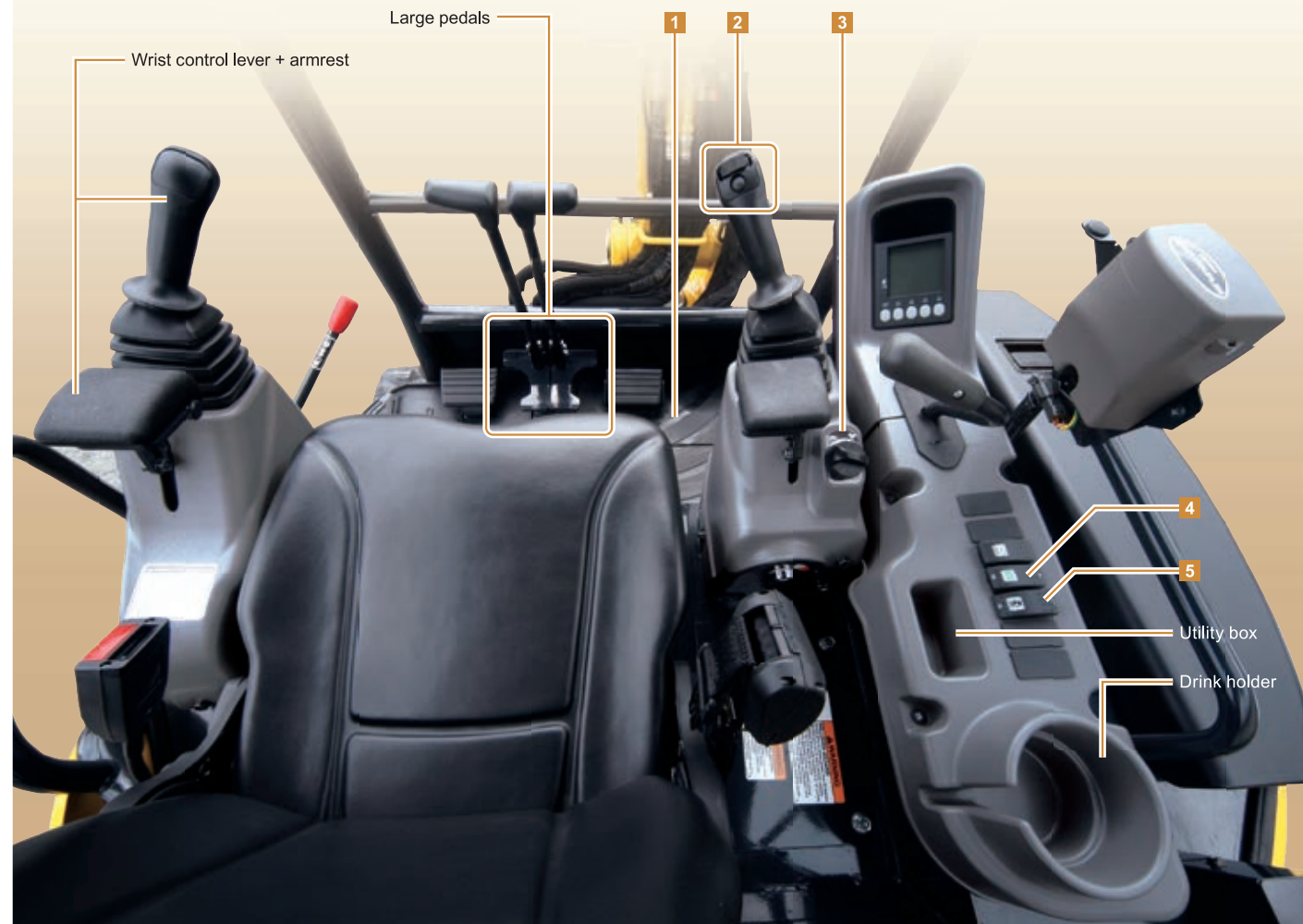

1 Plenty of foot room to keep you comfortable
[Full-flat floor]



2 [PTO proportional dial]

3 You can easily control engine speed at your fingertips
[Dial-type accelerator knob]

4 [Eco Mode switch]

5 [Auto Deceleration switch]



[External power socket (12V)]



[Slim satchel space behind the seat]



More Efficient Maintenance

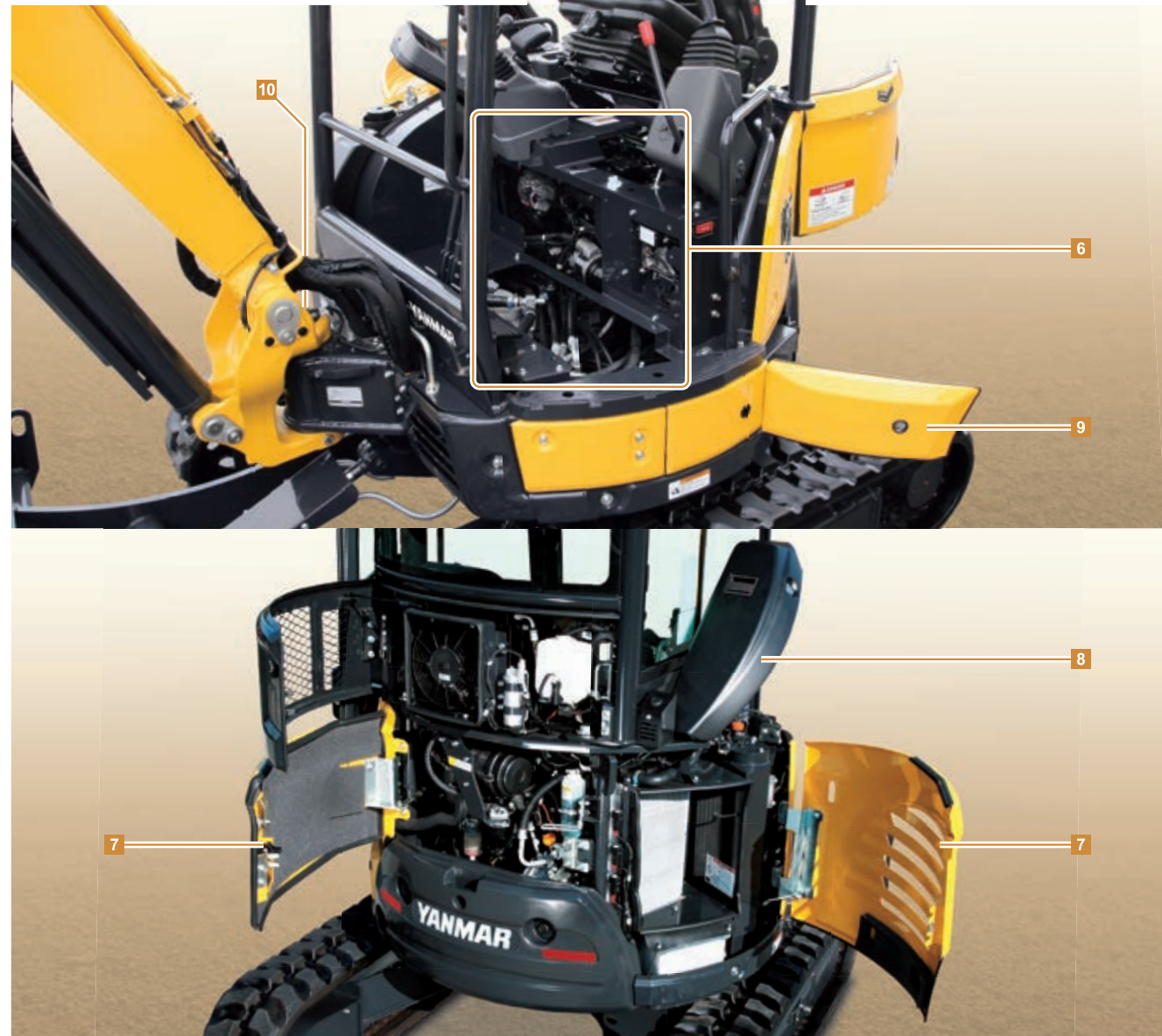

6 [Open around the operator's seat]

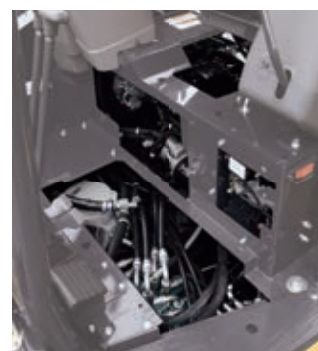

7 [Rear hood, right hood open without tools]



8 [Right upper opens without tools]



9 [Toolbox]



10 [Fuel tank drain cock]



Options

CABIN SPEC

Vi030-6B

Vi035-6B

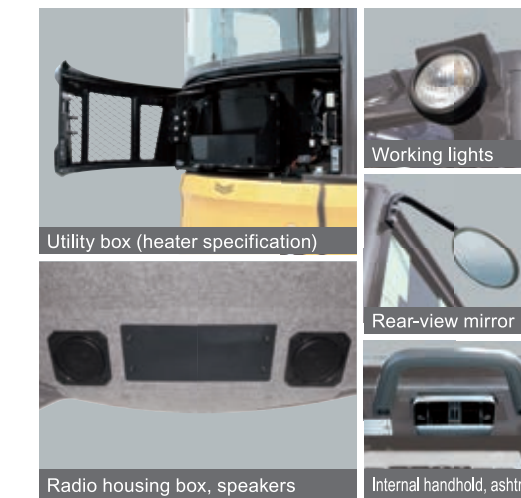

[Air-conditioner condenser]
The air-conditioner condenser is built into the cabin rear.
Hood open without tools.

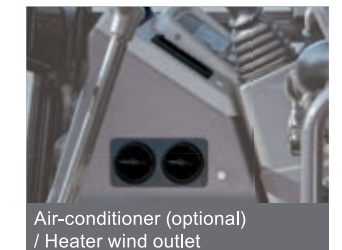

Quick Coupler

Simple and easy replacement of attachments

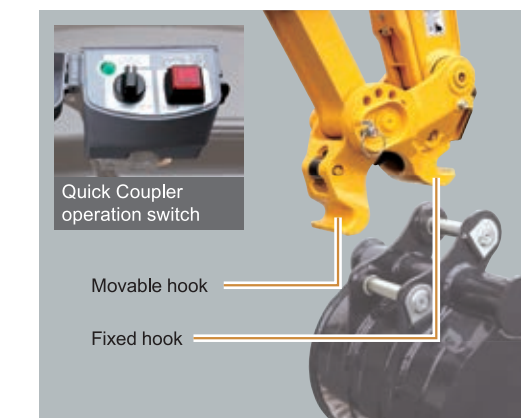

Bucket Removal



Bucket Attachment

