



# Vi025-6A

[Gross] 15.2kW (20.4hp)

**Dimensions** Unit : mm (ft-in)

	Canopy spec		Cabin spec	
	Quick coupler	without Quick coupler	Quick coupler	without Quick coupler
A	2950 (9'8")	2790 (9'2")	2950 (9'8")	2790 (9'2")
B	3150 (10'4")	2990 (9'10")	3150 (10'4")	2990 (9'10")
C	2370 (7'9")	2490 (8'2")	2370 (7'9")	2490 (8'2")
D	4910 (16'1")	4750 (15'7")	4910 (16'1")	4750 (15'7")
E	4800 (15'9")	4640 (15'3")	4800 (15'9")	4640 (15'3")
F	4090 (13'5")	4120 (13'6")	4090 (13'5")	4120 (13'6")
G	1580 (5'2")	1370 (4'6")	1580 (5'2")	1370 (4'6")
H	1380 (4'6")			
I	2040 (6'8")			
J	355 (1'2")			
K	340 (1'1")			
L	2490 (8'2")		2530 (8'4")	
M	2160 (7'1")	1990 (6'5")	2160 (7'1")	1990 (6'6")
N	Swing 1840 (6'0")	Swing 1680 (5'6")	Swing 1840 (6'0")	Swing 1680 (5'6")
O	585 (1'11")	705 (2'4")	585 (1'11")	705 (2'4")
P	2780 (9'1")	2930 (9'7")	2780 (9'1")	2930 (9'7")
Q	4480 (14'8")	4330 (14'2")	4480 (14'8")	4330 (14'2")
R	1500 (4'11")			
S	1250 (4'1")			
T	250 (0'10")			
U	320 (1'1")			
V	485 (1'7")			
W	705 (2'4")			
X	490 (1'7")			
Y	35 (0'1")			
Z	145 (0'6")			
	1500 (4'11")			

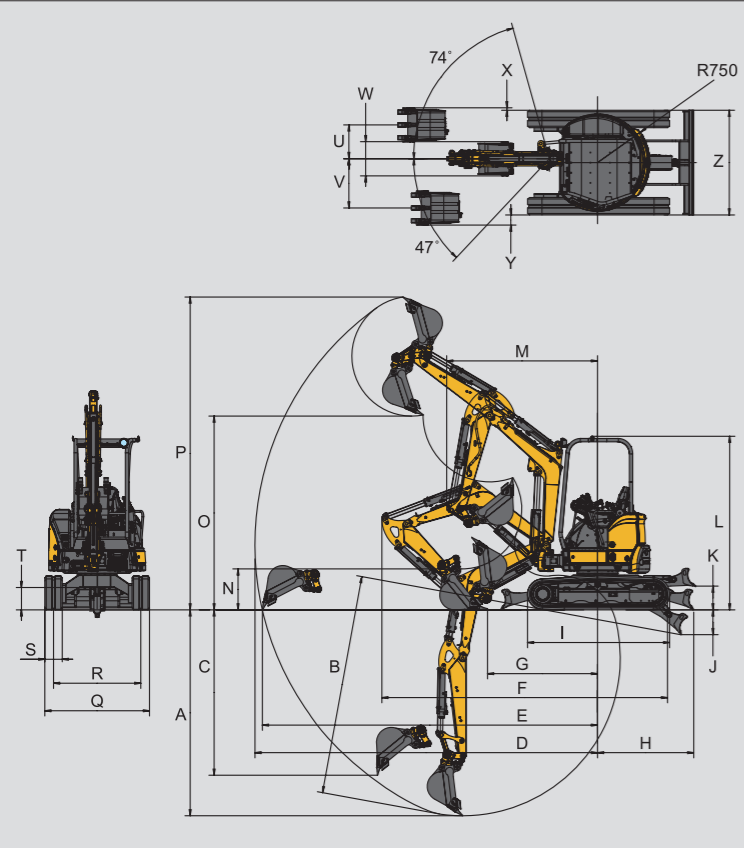

**Specifications**

Model		Vi025-6A				
Spec		Canopy		Cabin		
Type		Quick coupler	without Quick coupler	Quick coupler	without Quick coupler	
<b>Operating weight</b>	Rubber track	kg (lbs)	2685 (5919)	2635 (5809)	2815 (6206)	2765 (6096)
	Steel track	kg (lbs)	2795 (6162)	2745 (6052)	2925 (6449)	2875 (6338)
<b>Engine</b>	Type	-	4cycle, vertical inline, water-cooled diesel			
	Model	-	YANMAR 3TNV80F-SXNBV			
	Rated output	kW (hp) / rpm	15.2 (20.4) / 2500			
<b>Performance</b>	Bucket capacity, standard (ISO heaped)	cu.m (cu.ft)	0.08 (2.83)			
	Bucket width, standard (ISO heaped)	mm (in)	490 (19.3)			
	Max digging force, bucket	kN (lbf)	18.2 (4079)	23.1 (5203)	18.2 (4079)	23.1 (5203)
	Traveling speed, Rubber track	km / h (MPH)	4.5 (2.8) / 2.8 (1.7)			
	High / Low Steel track	km / h (MPH)				
	Swing speed	rpm	10			
	Boom swing angle, (L / R)	degrees	47 / 74			
<b>Ground contact pressure</b>	Rubber track	kPa (PSI)	30.2 (4.38)	29.6 (4.30)	31.7 (4.59)	31.1 (4.52)
	Steel track	kPa (PSI)	31.4 (4.55)	30.8 (4.47)	32.8 (4.77)	32.3 (4.69)
<b>Hydraulic system</b>	Pump capacity	L / min (GPM)	30.0 (7.9)x2 [Variable displacement pump], 21.3 (5.6)x1, 11.3 (3.0)x1 [Gear pump]			
	Main relief set pressure	MPa (PSI)	20.6 (2987) x 2, 18.1 (2631) x 1, 2.9 (427) x 1			
<b>Fuel tank capacity</b>		L (Gals)	30.5 (8.07)			

**Hydraulic PTO**

Model		Vi025-6A		
Specification		Output	L / min (GPM)	
		MPa (PSI)	2500RPM	1400RPM
<b>Combined flow, double actions</b>		20.6 (2987)	51.3 (13.6)	28.7 (7.58)

**Standard equipment**

- Blade
- Boom swing function
- Cylinder cover (boom, arm, bucket, blade)
- Rubber or Steel tracks
- Rearview mirror (cabin)
- Work light on canopy
- ROPS / FOPS Canopy, Cabin
- Windshield washer (cabin)
- Lock lever
- LCD monitor
- Joystick pilot controls
- Arm rests
- Suspension and reclining seat
- Retractable seat belt
- Proportional P.T.O mode
- Eco mode
- Engine stop switch
- External power socket (12V)
- Cup holder
- Floor mats
- Evacuation hammer (cabin)

Please note that the standard equipment may vary from this list. Consult your Yanmar dealer for confirmation



**YANMAR CONSTRUCTION EQUIPMENT CO.,LTD.**

OVERSEAS SALES DEPT.  
MARKETING & SALES DEPT.

1717-1 Kumano, Chikugo, Fukuoka 833-0055, JAPAN  
TEL +81-942-53-5465 FAX +81-942-53-5132

yanmar.com

All data subject to change without notice.



# UNBEATABLE PERFORMANCE

The new and compact ViO25-6A, delivers on top performance.

## Equipped with a next-generation electronically controlled engine

Equipped with a next-generation electronically controlled engine having a great power output on tap, Yanmar's TNV engine is the result of our endless pursuit for advancements in technology.

An improved fuel injection system allow for even cleaner emissions and reduced noise.



3TNV80F

**15.2kW** / 2500rpm

Compliant with EPA Tier 4 standards

## Powerful lifting capacity

With powerful lifting capacity the ViO25-6A enables you to work much more efficiently.

Over front, blade down



**520kg**  
(1146lbs)

Over side, blade up



**270kg**  
(595lbs)

Ground level, without Quick coupler

## Maximum digging force

The ViO25-6A has a strong digging force for maximizing work productivity.

**23.1kN**  
(5203lbs)

Bucket, without Quick coupler



## True zero tail swing

Yanmar pioneered the concept of a true zero tail swing mini excavator for operating without overhang on the tight job sites.

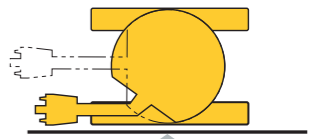

**No overhang**

**Compact size: Can be loaded onto a 3 ton truck**

**The canopy complies with ROPS and FOPS ISO standards**

**Protected work light**



**Spring steel cylinder guards protect the cylinder rods**



## Option

### Auto deceleration

If the operating levers have been in neutral for more than 4 seconds, the engine automatically returns to idle, reducing noise, emissions and fuel consumption.



### Yanmar's original Quick coupler

For ultra-fast changes of attachment.

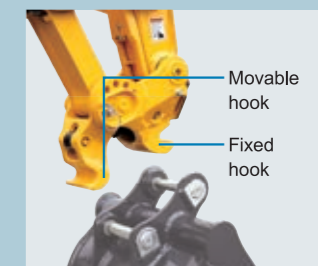

Quick coupler operation switches



# UNIVERSAL DESIGN (UD) COMFORTABILITY

Easy Operation

The universal design gives you comfort for enhanced productivity.

Operating controls and switches are ergonomically arranged for easy reach

UD Canopy gives you the space needed to be more productive

## P.T.O (auxiliary hydraulic) proportional control

The VIO25-6A has a P.T.O proportional control lever with a hold button for easy control when using attachments.

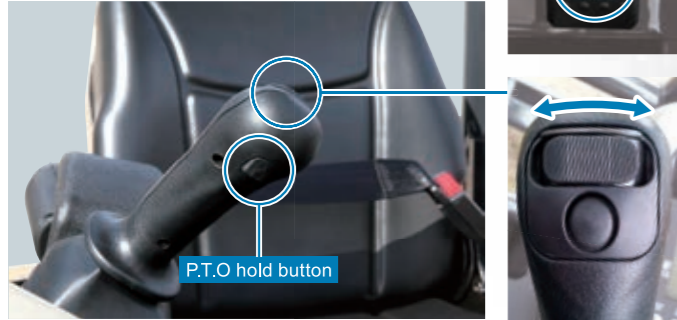

P.T.O hold button

Adjust lever

## Boom swing by right control joy stick

Boom swing is controlled by just one lever. Being able to control the boom swing with the lever to the right of the joystick makes work so much easier. Additionally, having no boom swing pedal gives you more legroom. To control the boom, turn boom swing mode on and move the lever left or right.

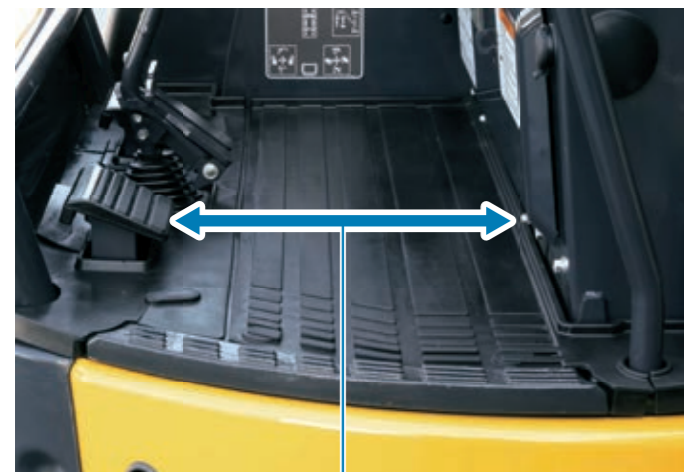

Flat and spacious leg room **385mm (1'3")**

Joystick lever & Arm rest

Seat belt

LCD action monitor

Boom light switch

Engine acceleration lever [Standard spec]

P.T.O control mode / Boom swing mode switch

Quick coupler control box (Option)

## Comfortable reclining seat with storage compartment



The acceleration lever and dial let you adjust engine output easily



Lever [Standard spec]



Dial [Auto-decel. spec] (Option)

## 12V external power socket



New universal grab handles Easy to grip by either hand



## Cabin Spec

The cabin complies with ROPS and FOPS ISO standards

**Rearview mirror**  
Standardly equipped.



**Door handle**  
Easy to grip by either hand.



**Assist bar**  
Easy to grip, Getting in / out easily.





# EASY MAINTENANCE

The new LCD monitor provides useful information, including maintenance intervals and alert system for smart machine maintenance.

## Large-screen LCD monitor

The monitor allows you to check not only the status of the machine, but last 3 months operation history as well.

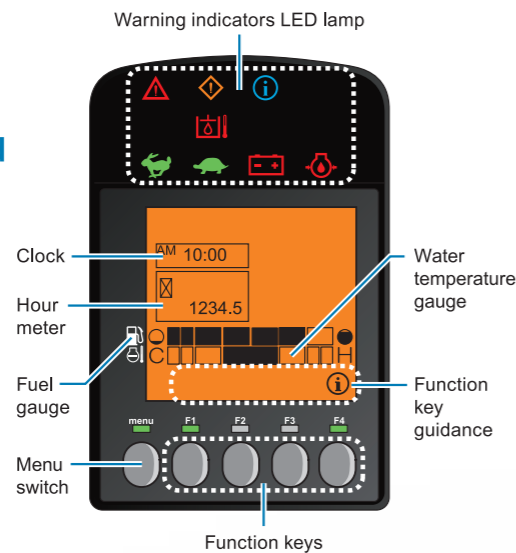

### Display examples

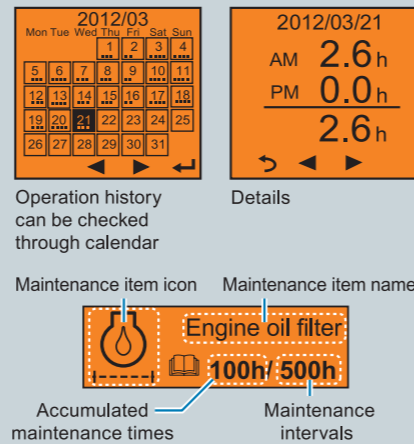

Opens right up without special tools giving you easy access for daily checks and maintenance of the engine area.



The right compartment also opens right up and without special tools, when checking the radiator. The radiator is easy to clean and the wave fin design reduces the potential for clogging.

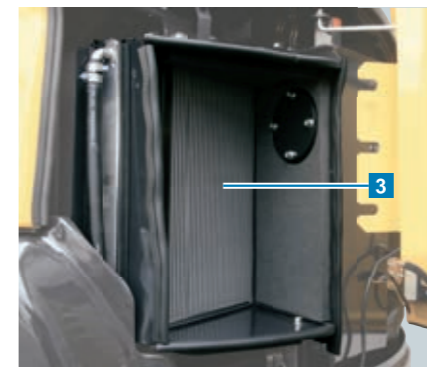

The upper right compartment opens up without special tools. This allows for simplified maintenance of the battery, fuel tank and hydraulic oil tank.

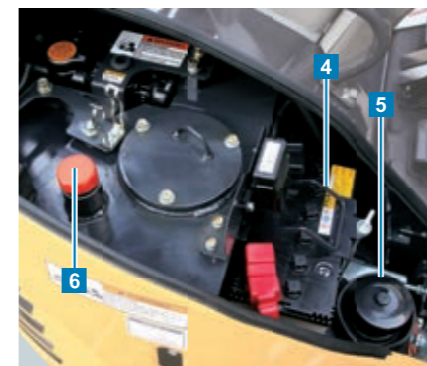

Easy to open around the operators' seat for easy maintenance of the hydraulic generator and electrical parts.

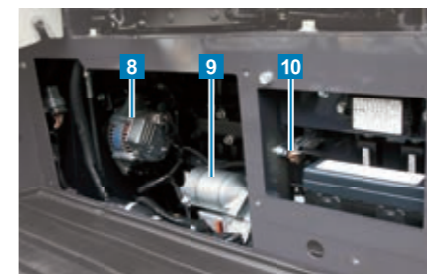

## Simplified for fast and easy maintenance

Covers are easily open without special tools, enables fast and smooth checks and minimizing maintenance and cleaning time.

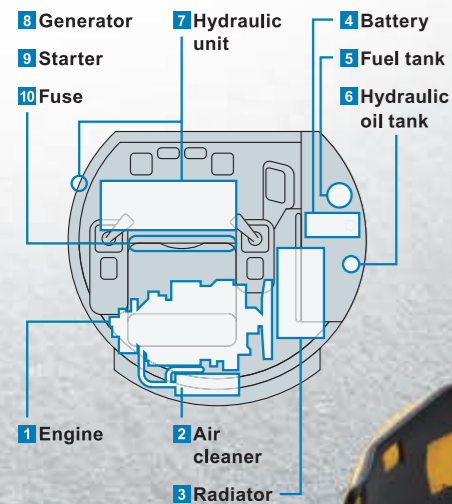

## Simplified Maintenance

### Lifting capacity

Excavator equipped with ROPS/FOPS and rubber tracks (without quick coupler and without bucket)

r : Reach from swing center line : mm(in)  
h : Lift point height : mm(in)  
w : Lifting capacity : kg(lbs)  
P : Lift point

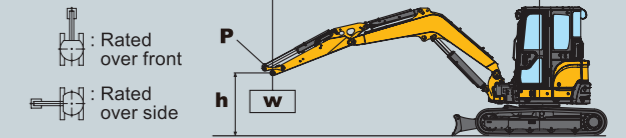

- The rated lifting capacities that are indicated below are based on ISO 10567 and do not exceed 87% of the excavator's hydraulic lifting capacity or 75% of its static tilt load (tipping load) capacity.
- The following operating criteria are also applicable to the calculation of these maximum loads:
  - The "Lift point" is the location of the front point on the arm
  - The three indicated machine position are : (i) arm over the front end (blade down), (ii) arm over the front end (blade up), and (iii) arm over the side (blade up).
- The weight of the excavator's bucket, hook, sling and other lifting accessories have been taken into consideration when calculating these maximum loads.

LIFT POINT HEIGHT h : mm (ft-in)	r : REACH mm (ft-in)			
<b>RATED LIFT CAPACITY OVER END BLADE DOWN : kg (lbs)</b>				
	MAX	3000 (9'10")	2500 (8'2")	2000 (6'7")
3000 (9'10")	* 460(1014)			
2500 (8'2")	* 460(1014)	* 460(1014)		
2000 (6'7")	* 470(1036)	* 460(1014)		
1000 (3'3")	* 490(1080)	* 620(1366)	* 760(1675)	
0 (Ground)	* 520(1146)	* 730(1609)	* 950(2094)	* 1310(2888)
-1000 (-3'3")	* 540(1190)	* 700(1543)	* 920(2028)	* 1200(2645)
-1500 (-4'11")	* 530(1168)		* 760(1675)	* 960(2116)
<b>RATED LIFT CAPACITY OVER END BLADE UP : kg (lbs)</b>				
	MAX	3000 (9'10")	2500 (8'2")	2000 (6'7")
3000 (9'10")	* 450(992)			
2500 (8'2")	400(881)	* 460(1014)		
2000 (6'7")	360(793)	* 460(1014)		
1000 (3'3")	320(705)	* 600(1322)	* 760(1675)	
0 (Ground)	330(727)	480(1058)	630(1388)	890(1962)
-1000 (-3'3")	390(859)	470(1036)	600(1322)	870(1918)
-1500 (-4'11")	470(1036)		610(1344)	840(1851)
<b>RATED LIFT CAPACITY OVER SIDE BLADE UP : kg (lbs)</b>				
	MAX	9'10" (3000)	8'2" (2500)	6'7" (2000)
3000 (9'10")	380(837)			
2500 (8'2")	330(727)	* 450(992)		
2000 (6'7")	300(661)	360(793)		
1000 (3'3")	270(595)	440(970)	* 760(1675)	
0 (Ground)	270(595)	400(881)	510(1124)	690(1521)
-1000 (-3'3")	320(705)	380(837)	500(1102)	700(1543)
-1500 (-4'11")	400(881)		510(1124)	680(1499)

Note : The maximum loads marked with an asterisk (\*) were limited by the Excavator's hydraulic lifting capacity rather than by its static tilt load (tipping load) capacity.