

SUMITOMO

SH80-6B

- Engine Rated Power (Net): 41.1 kW · 55.8 PS
- Operating Weight: SH80-6B 7,550 kg
- Bucket Capacity (ISO Heaped): 0.38 m³



SUMITOMO



 **SUMITOMO CONSTRUCTION MACHINERY CO., LTD.**

731-1 Naganumahara-cho, Inage-ku, Chiba, 263-0001 Japan
For further information please contact: Phone : +81-43-420-1829 Facsimile : +81-43-420-1907

We are constantly improving our products and therefore reserve the right to change designs and specifications without notice.
Illustrations may include optional equipment and accessories and may not include all standard equipment.

Big on style, big on work

LEGEST

SH80-6B is here,
unprecedented comfort and performance



Introducing a new style excavator for those users with confidence and pride in their skills, seeking a high level of comfort and performance in their machines. Combining the agile mobility of a compact excavator with a stylish design that is simply stunning, the SH80-6B redefines the meaning of easy usability and solid performance. The largest bucket in its class is designed to deliver exceptional workability and performance. Big style and big work that only Sumitomo can provide - a must-have excavator for those who want to see a real difference on their worksite.

Unprecedented style and workability

- Cab designed with unique style
- Equipped with a class top 0.38 m³ bucket
- Better loading and close proximity work

Unprecedented comfort and safety

- Cabin with an exceptional level of comfort
- Major improvements to visibility
- New range of accessories for greater comfort and safety

Unprecedented reliability and ease of maintenance

- Ground level access for simple inspections
- Designed for easier day-to-day maintenance

**Unprecedented style
and workability**

Advanced capabilities for greater confidence.

Exceptional performance in a well-styled package, the SH80-6B is equipped with the largest bucket in its class for performance that exceeds other brands. Faster work speed is a given, with control also drastically improved for an excavator that can be easily handled by any worker.

Styled to match its performance, the SH80-6B also provides exceptional comfort. Confidence and satisfaction are assured with every moment of use.



Class top

0.38m³

bucket for performance

The specially designed bucket tops the class at 0.38 m³. A greater workload drastically increases work speed and construction efficiency. In addition to the larger bucket, more powerful boom hydraulics improve performance of loading operation as well as working at close proximity. Introducing a new feel to every aspect of work performance.



Luxurious cab styling for great on-site presence

Cab concepts from other models are taken into new design for more comfortable cab and makes the excavator instantly stand out during work. The SH80-6B oozes presence on any site.

Excellent digging force

Both the arm and bucket are backed with class-leading digging force for smooth excavation work.

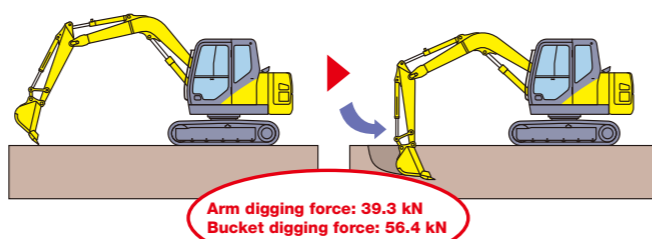

Greater truck dumping efficiency

Stronger boom hydraulics for smoother loading operation.

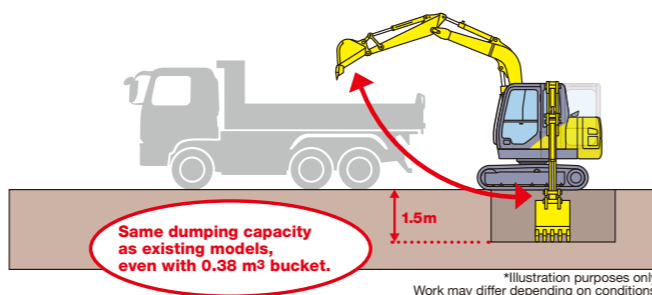

Better work at close proximities

Easier when working close to the excavator with the bottom of the bucket. The tips of the bucket and end of the blade overlap to make it easier to scoop up excess soil or rocks.

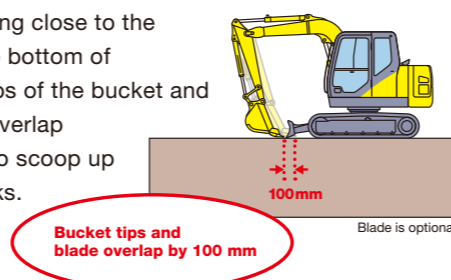

Special bucket designed for durability

The bucket has been designed exclusively for outstanding durability in tough environments, with features such as more effective use of stronger and thicker plates. Bucket pins use oil-impregnated sintered bushes designed for a long operating life.



Designed for excellent access

Wider door openings together with larger handrails and non-slip plate provide better access to the cab.



Large handrails



New non-slip plate

Engine compliant with U.S. EPA Tier 3 and Euro Stage III A exhaust gas regulations

The SH80-6B is powered by an engine for high power and outstanding eco-friendly driving. Compliant with U.S. EPA Tier 3 and Euro Stage III A exhaust gas regulations, the engine is also user-friendly with electric control governor and EGR system which contributes to excellent fuel efficiency to help reduce running costs.



High-rigidity cab to protect against rollovers

A stronger cab frame and other improvements drastically increase cab rigidity for further safety during unexpected rollovers.

●3-fold increase in rigidity

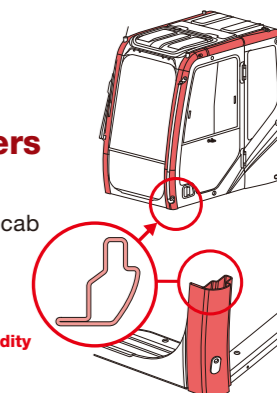

Wiper with rise-up mechanism

A wiper with rise-up mechanism has been used for better performance in the rain. This increases visibility when the wiper is sweeping, as the arm stay out of the way.



Cooled EGR system (air-cooled)

An air cooler is equipped with the EGR (Exhaust Gas Recirculation), which reduces the volume of exhaust gas by recirculating it. Increasing the EGR volume to limit combustion temperature helps to reduce NOx and fuel consumption even further.

One-touch idle and auto-idle function

Comes equipped with Sumitomo's proprietary one-touch idle and auto-idle functions, which help to minimise unnecessary fuel consumption and cut back fuel costs.



Ample 120 L capacity fuel tank

The high capacity fuel tank and low fuel consumption mean a longer time between refueling, and thus longer operation.

Safe and comfortable cabin for amenity and authority.

Thoroughly designed with the operator in mind, the new cab design of the SH80-6B improves operating visibility and safety with a wide, spacious interior reminiscent of larger class models. A full range of accessories are also available for added comfort, like reclining seats and auto air-conditioning. An unprecedented level of luxury ensures peace of mind during work, and ultimate relaxation during breaks for an all-round quality experience.



Cabin designed for comfort and reduced stress

A supreme interior finish that goes well beyond its class, super-comfortable seats and an ergonomically-arranged equipment layout. The SH80-6B interior is engineered for stress-free operation no matter how long the work is.

Comfortable reclining seat

The operator's seat comes with a full-range adjustment mechanism to ensure the optimum operating position, while the wider seat area is designed to reduce fatigue. Reclining is available over a larger range of angles, making rest times much more rewarding.



Ultra water and stain resistant seat

Seats with an excellent level of water-resistance have been used to protect against rain, dust and dirt with a water-repelling seat texture designed for a wide range of worksites.



Superb operating visibility for a safer worksite

The new cab and single glass sheet on the right ensure excellent operating visibility. The wide, unobstructed view means better safety for all.



Functional meters and switch panel

Simple, easy-to-read meters have been used. The switch panel has been designed to be read and controlled easily with its universal design.



Cab mounts for increased comfort

The fluid mounts efficiently absorb shocks and vibrations being transmitted throughout the cab to increase comfort and reduce fatigue.

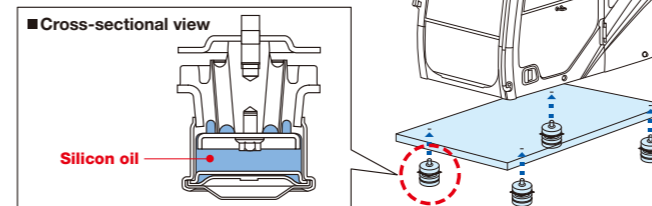

AM/FM stereo radio (with USB & AUX port)

An AM/FM stereo radio has been provided to enhance enjoyment. The USB and AUX ports allow users to listen to their favorite music through the radio speakers.



Auto air-conditioning for greater comfort

An auto air-conditioning system is installed as standard for greater comfort by optimising the layout of the air channels. The air vents feature round grills that can be adjusted over a wide range of angles, and the entire system is designed for greater comfort in the cabin to help reduce operator fatigue.



Truly spacious interior

Interior space has been greatly enlarged over the previous model (SH75-3B). A wide seat adjustment range means operators can customise the seat to their optimum position, regardless of their frame.

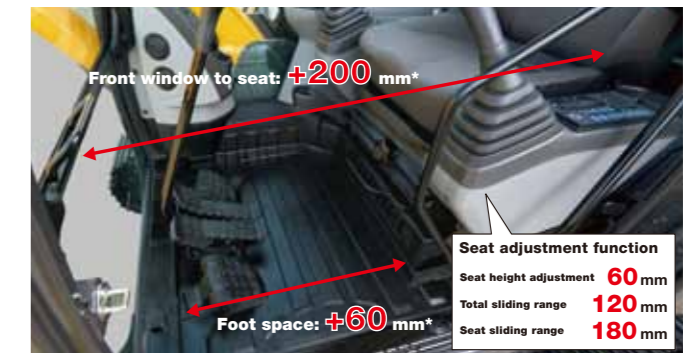

*Compared with the previous model, SH75-3B

Main accessories for increasing comfort



Multifunctional storage compartments



Safety accessories for the unexpected

Emergency stop switch



Ease of maintenance to minimise work interruptions.

Easy maintenance and tough durability are essential for an excavator to work for a long time. The SH80-6B provides ground level access that makes daily maintenance and management so much easier. High level of cooling performance required for peace of mind during heavy lifting, better durability of each part, longer operating life of joints and a whole host of other mechanical improvements have been made to every component. Reliability for non-stop work is another quality feature that makes a positive difference.

Ground level access for easier inspection and maintenance

Components requiring inspections are located at centre so that inspections, maintenance, cleaning and refilling work can be conducted without having to climb onto upper structure of the excavator. Outstanding cleaning capability helps to improve reliability under high load work and makes the dustproof net easier to clean.



● Designed for cooling

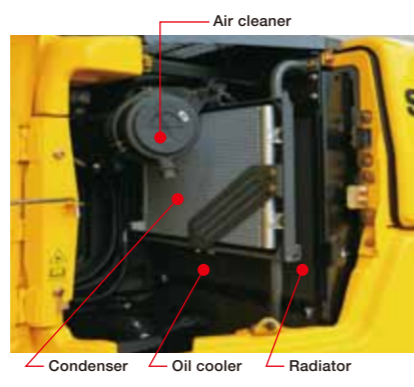

Air cleaner
Condenser
Oil cooler
Radiator

● Easy filter replacement

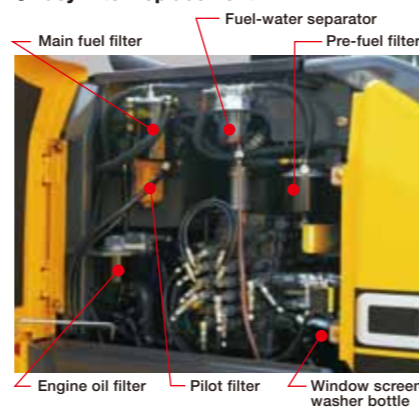

Main fuel filter
Fuel-water separator
Pre-fuel filter
Engine oil filter
Pilot filter
Window screen washer bottle

One-touch release front face protection net for radiator

The front face protection net for radiator can be removed for cleaning. Trapped dust, dirt and other material can be cleaned off to clear blockages and restore engine cooling performance.



*) Blockage of the front face protection net for radiator can cause malfunctions. Clean the net regularly.

● Body design for easy maintenance



Grease tub storage space
Air-conditioning unit external filter (behind battery)
Box of tools

Easier to clean cab floor

The edges around the floor mat are higher, and the addition of a lip make it easy to wash clean the dirty cab floor with water.



Even greater rigidity

A lightweight, high-rigidity and high-strength type structure has been used for the boom and arm that is essential for excavator operations. This helps to increase work precision, as well as ensure more than adequate durability for a wide range of worksites and heavy loads.

■ Boom

Plate thickness increased for left and right surfaces of boom for better reliability

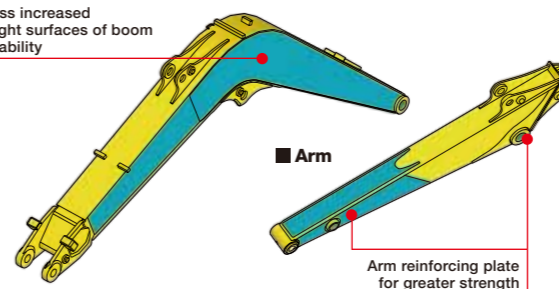

■ Arm

Arm reinforcing plate for greater strength

■ High-rigidity swing frame

A single-plate high-rigidity swing frame has been used. This helps protect equipment and hoses from sharp objects beneath the frame.

■ Increased track link M-type seal + pin rigidity

M-type seals with excellent sealing characteristics help to retain grease for longer. Increased hardness also helps to reduce pin wear. The result is a longer link service life and less operating noise.

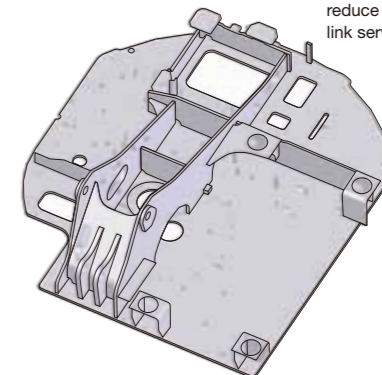

EMS for outstanding maintenance of joints

The new EMS (Easy Maintenance System) uses newly designed steel bushes and keeps joints constantly lubricated, with 250-hour greasing intervals around the bucket, and 1,000-hour greasing intervals for other sections. This reduces wear and rattling, and significantly extends the service life of the components.

- Bucket greasing interval: **250 hours**
- Greasing interval for other sections: **1,000 hours**

* The greasing interval depends on the working conditions.



→ Sections with new EMS bushes
→ Sections with EMS bushes

■ EMS bushes

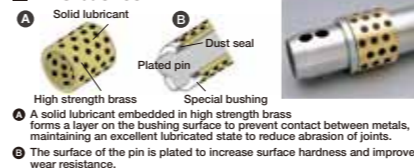

A Solid lubricant
B Dust seal
Plated pin
Special bushing
High strength brass
A solid lubricant embedded in high strength brass forms a layer on the bushing surface to prevent contact between metals, maintaining an excellent lubricated state to reduce abrasion of joints.
② The surface of the pin is plated to increase surface hardness and improve wear resistance.

Precautionary use of EMS

- (1) Grease is enclosed, however greasing is necessary every 1,000 hours or six months depending on the level of dusting conditions.
- (2) Greasing is also necessary after any components have been submerged underwater for prolonged periods.
- (3) Greasing is also recommended after use with hydraulic breakers, crushers or other high impact attachments such as rock saws.
- (4) Bucket pins should be cleaned thoroughly when removing or attaching new buckets.

High-performance return filter for extending maintenance intervals

A high-performance return filter has been used for a hydraulic oil change interval of 5,000 hours, and filter service life of 2,000 hours, thus reducing maintenance work and cost.

- Hydraulic oil change: **5,000 hours**
- Life of filter: **2,000 hours**



* The oil and filter change interval varies depending on the working conditions.

■ Main Equipment

[Hydraulic system]

- High-performance cleaning filter
- Automatic 2-speed travel
- Aux. valve

[Safety equipment]

- Rearview mirror (left/right)
- Engine neutral start function
- Seat belt
- Travel alarm
- Engine room firewall
- Fan guard
- Engine emergency stop switch
- Gate lock lever

[Cab/interior equipment]

- Seat suspension
- Fluid mounts
- Full-automatic air-conditioner with external air intake
- Water-resistant operator's seat
- Interior lamp (with auto-off function)
- AM/FM stereo radio (with USB & AUX port)
- Floor mat
- Armrest and headrest
- Defroster
- Wiper with rise-up mechanism
- Cup holder
- Clock
- Magazine rack
- Accessory case
- Ashtray and cigarette lighter
- Coat hook

[Others]

- Engine compliant with U.S. EPA Tier 3 and Euro Stage III A exhaust gas regulations
- New EMS (Easy Maintenance System)
- Long-life hydraulic oil
- Front face protective net for radiator
- Tool kit
- Grease gun
- One-touch idle and auto-idle function
- Two lights (top of cab, left of boom)
- Fuel filter
- Fuel pre-filter
- Fuel-water separator
- Double-element air cleaner
- Grease-enclosed links
- Bucket anti-clatter
- Toolbox

■ Accessories

○:standard ●:optional

SH80-6B		STD specifications	Blade specifications
Base	450 mm grouser shoe	○	○
	600 mm grouser shoe	●	●
	Lower under cover	○	○
	Blade	—	○
Bucket	0.38 m ³	○	○
Arm	1.69 m	○	○
Boom	3.5 m	○	○
Auxiliary piping	Breaker circuit	●	●
Cab interior equipment/ other	AM/FM stereo radio	○	○
	12 V power (DC-DC converter)	●	●
	Cab head guard (FOPS level 2)	●	●
	Cab-top lights	○	○
	Boom foot light	●	●

■ Accessories (option)



Head guard (FOPS level 2)



12 V power

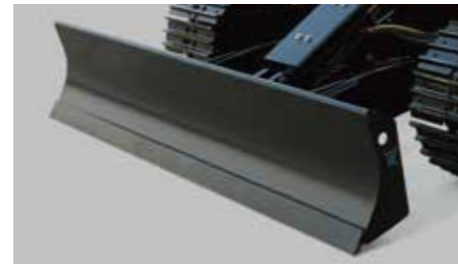

Blade



■ Main Specifications

SH80-6B		
Basic	Bucket capacity	0.38 m ³
	Operating weight	7,550 kg
	Engine: make & model	Yanmar 4TNV98-Z
	Rated output	41.1 kW/2,000 min ⁻¹
	Displacement	3,318 L (3,318 cc)
Dimensions	Total transportation length	6,090 mm
	Total transportation width	2,320 mm
	Total transportation height	2,750 mm
	Total crawler length	2,845 mm
	Total crawler width	2,320 mm
	Standard shoe width	450 (grouser shoe) mm
Performance	Travel speed: high/low	5.0/3.1 km/h
	Gradeability	70% (35°)
	Swing speed	11.1 min ⁻¹
	Bucket digging force	56.4 kN
	Bucket arm force	39.3 kN
Hydraulic equipment	Pump type	1 x double variable displacement axial piston pump
	Maximum pressure	29.4 MPa
	Travel motor	2 x variable displacement axial piston motors
	Parking brake	Mechanical lock
	Swing motor	1 x fixed displacement axial piston motor
Capacity	Fuel tank capacity	120 L
	Hydraulic oil tank capacity	51 L

■ Dimensions

Unit: mm

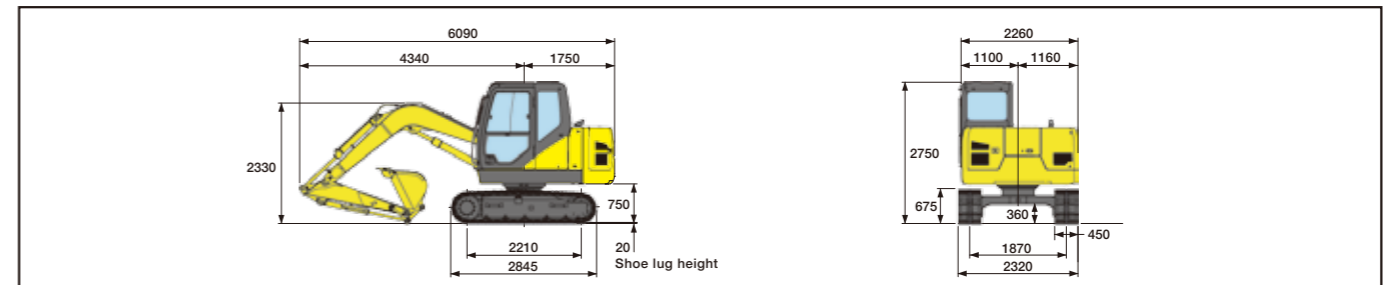

■ Working Range

